

MAGRAV Power Unit: Build and Grow

Keshe Foundation R&D Group



Lists of Items

- 1.) Gauge #14 Solid Copper Wire - about 20-30 meters to make 3 sets of MAGRAV COILS
- 2.) Nano Coating Kit (Refer to Videos of You Tube)
- 3.) Hand Drill with 2 rods for inner and outer coil forming
or 2 Screw Drivers with different rod diameter that can be inner and outer coils former
- 4.) Gans Mix for Coating the Coils and putting on the Center Gans Container
- 5.) Plasma Capacitor - 2-3 Units
- 6.) A lot of Patience, Prayers and Love in doing your MAGRAV Power Unit

Coils Specifications

- 1.) **All Coiled Counter Clockwise (use the Right Thumb Rule - by pointing your Right Thumb towards you and curl your 4 fingers to the left going in your palm- The Curl is the Direction of Turn)**
- 2.) Diameter of Loop Coils Varies on tubes use to make the coils.
- 3.) Magnetical Loop (Outer) consists of 2 coils Magnetical Coil (outer) and Gravitational Coil (inner)
- 140-160 Turns
- 4.) Gravitational Loop (Inner) consists of 2 coils Magnetical Coil (outer) and Gravitational Coil (inner)
- 70-80 Turns

Steps

- 1.) Pray and Make the Coils- 3 sets.
- 2.) Nano-Coat the Coils using Standard Caustic Method and proper Drying.
- 3.) Coating the Coils with Gans Mix (Paste/Liquid) and Dry it properly.
- 4.) Assemble the Coils and Connect properly (make sure to fold the ends of the wires towards itself)
- 5.) Assemble the casing and properly arrange and stack all parts including the Gans Center Container
- 6.) Connect the Plasma Capacitor Properly.
- 7.) Check the Connections again (you can use electrical shrink tape to hold the connections)
- 8.) Install proper Switches or Breakers to the System
- 9.) Always consult an Electrical Engineer or Technician when connecting to the Main Power Line
- 10.) Build another one for your Neighbor and Relatives

MAGRAV Coil Circuit Connection

Keshe Foundation R&D Group
August 30, 2015

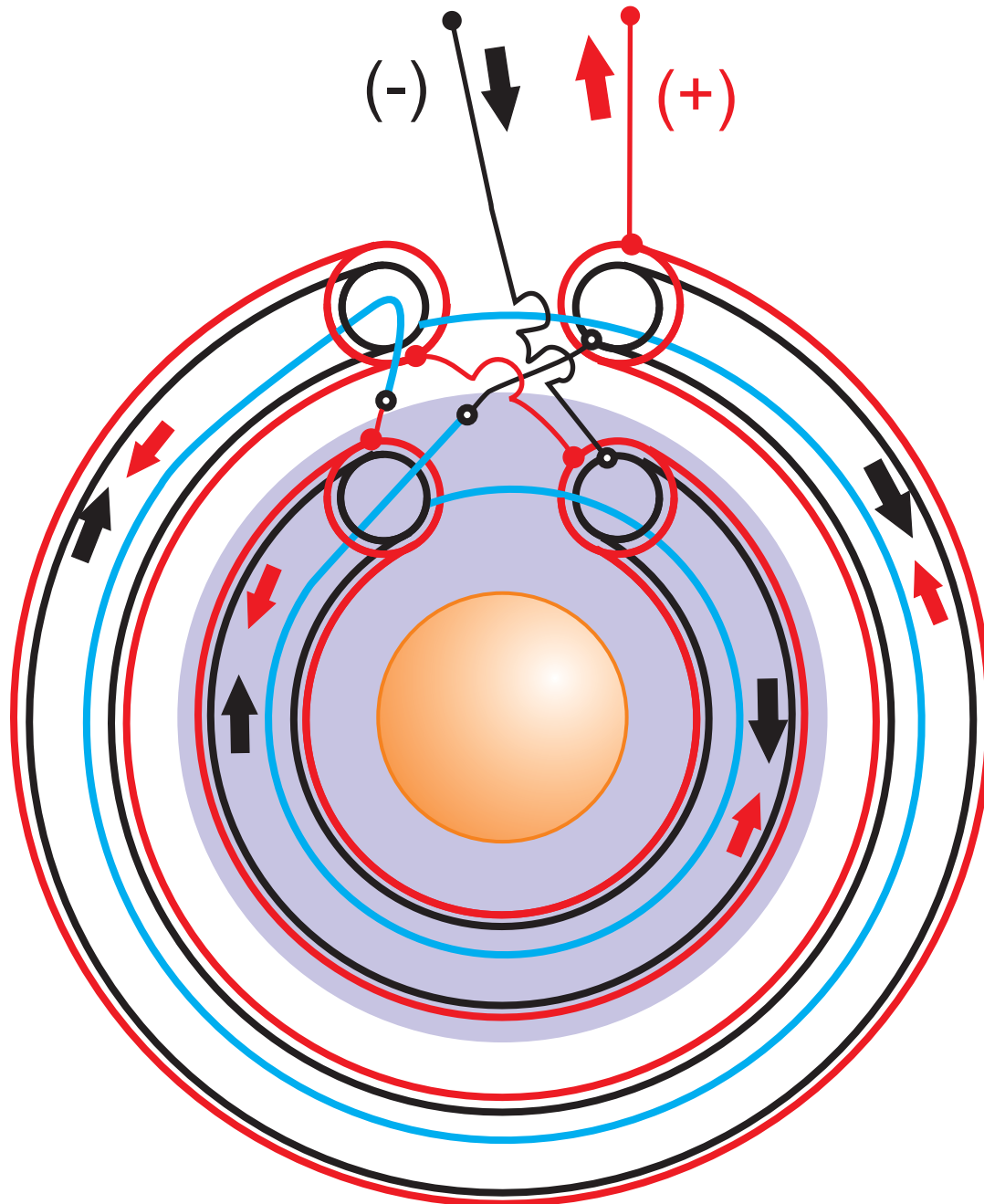

- Magnetical Coil**
- Gravitational Coil**
- Extended Wire from Gravitational Coisl**
- Gravitational Coil End**
- Magnetical Coil End**
- Magnetical Plasma Flow**
- Gravitational Plasma Flow**
- Gans Container**

Specifications:

Gauge #14 Solid Copper Wire

All Coiled Counter Clockwise

Diameter of Loop Coils Varies on tubes use to make the coils.

> **Magnetical Loop** (Outer) consists of 2 coils Magnetical Coil (outer) and Gravitational Coil (inner) - 162 Turns

> **Gravitational Loop** (Inner) consists of 2 coils Magnetical Coil (outer) and Gravitational Coil - 81 Turns

MAGRAV Coil Circuit Stacked & connected in Series

Keshe Foundation R&D Group
August 30, 2015



Note:

1. Connecting wires must be nano-coated.
2. Always twist the ends of the wire back to itself.

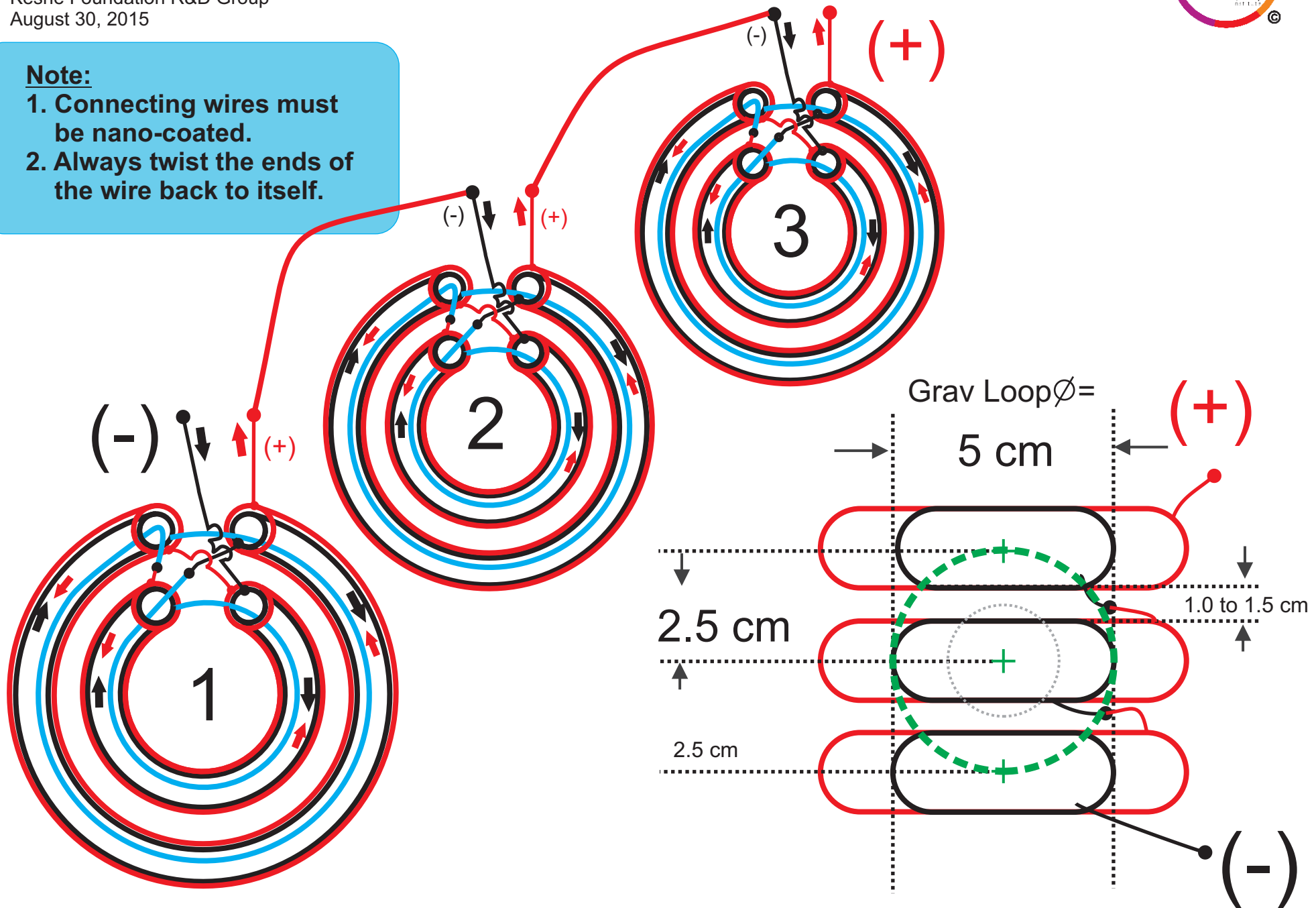

Plasma Capacitor (Single Layer)

Keshe Foundation R&D Group
October 30, 2015 - Edited October 31, 2015

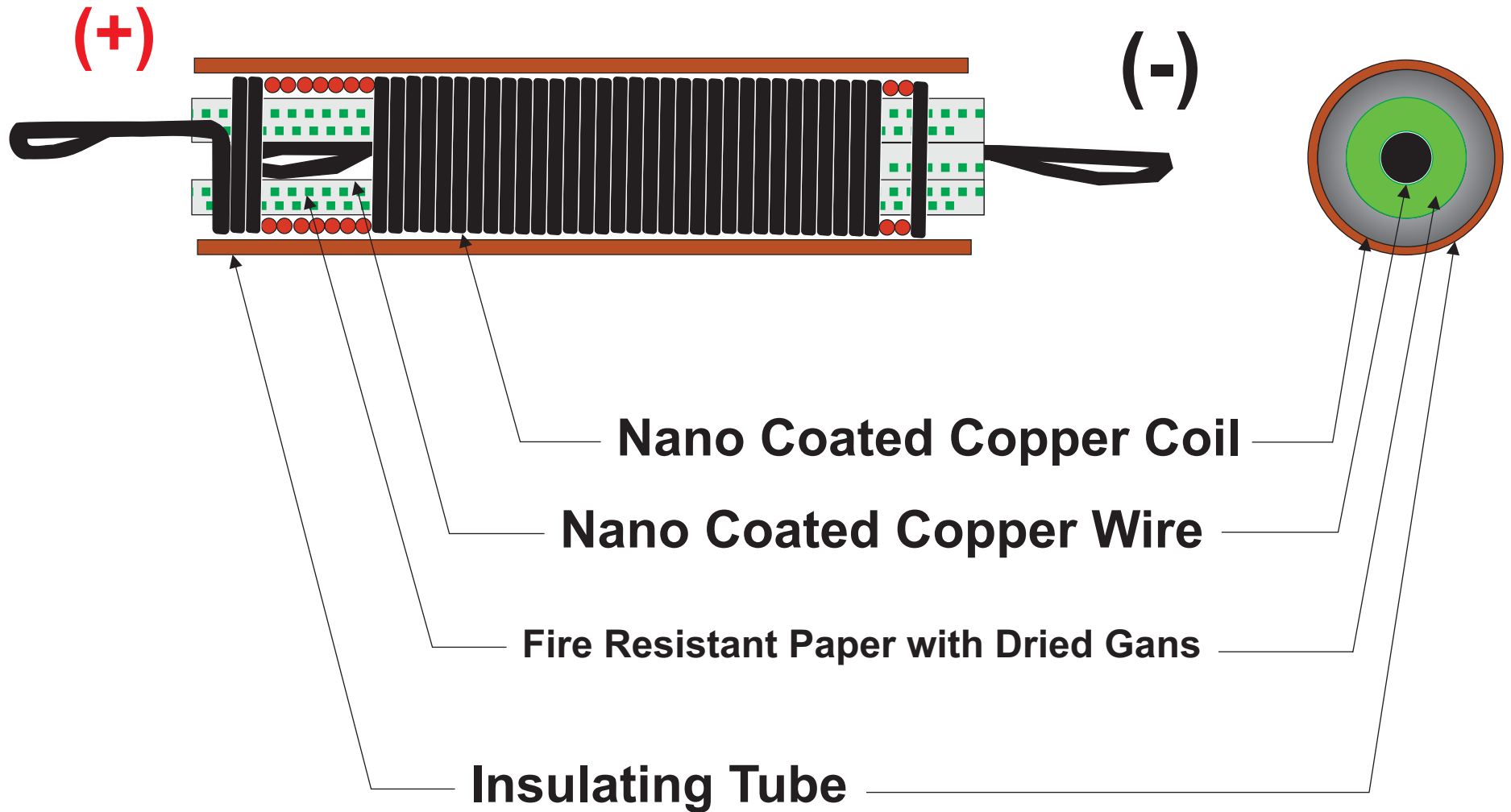

MAGRAV Power AC Grid Connection- Config 1

Keshe Foundation R&D Group
August 30, 2015

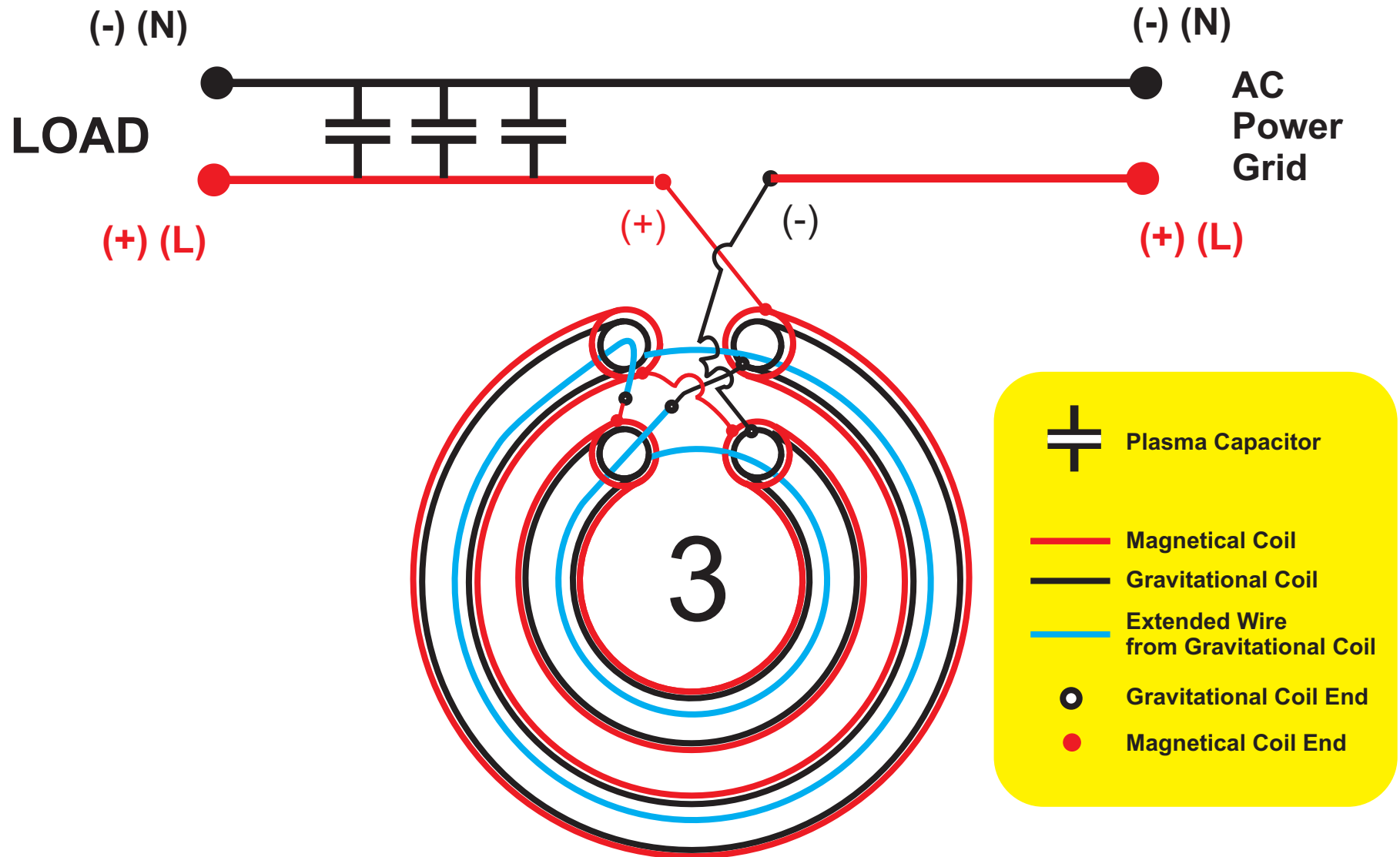

MAGRAV Power AC Grid Connection- Config 2

Keshe Foundation R&D Group
August 30, 2015

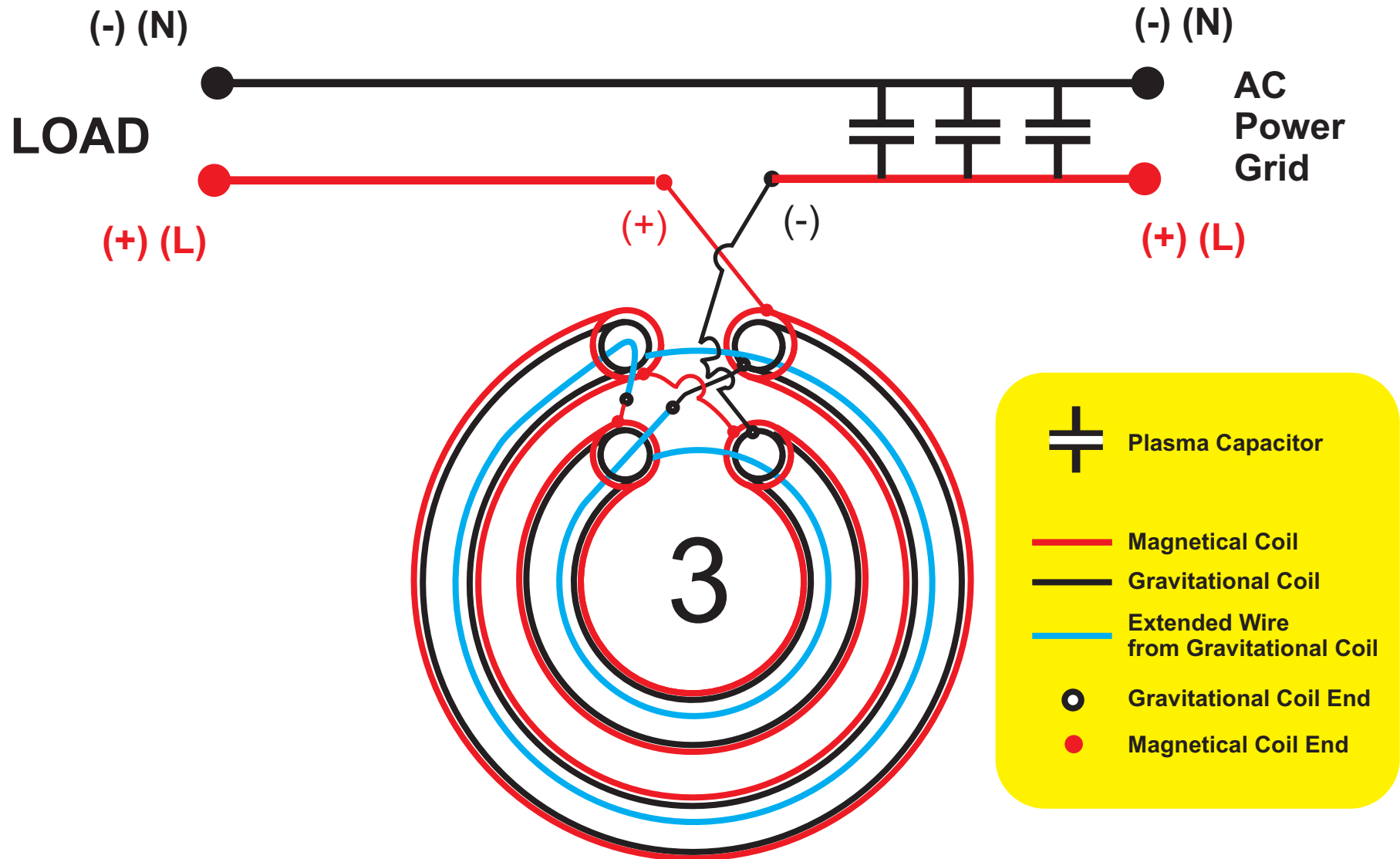

MAGRAV Power AC Grid Connection- Config 3

Keshe Foundation R&D Group
August 30, 2015

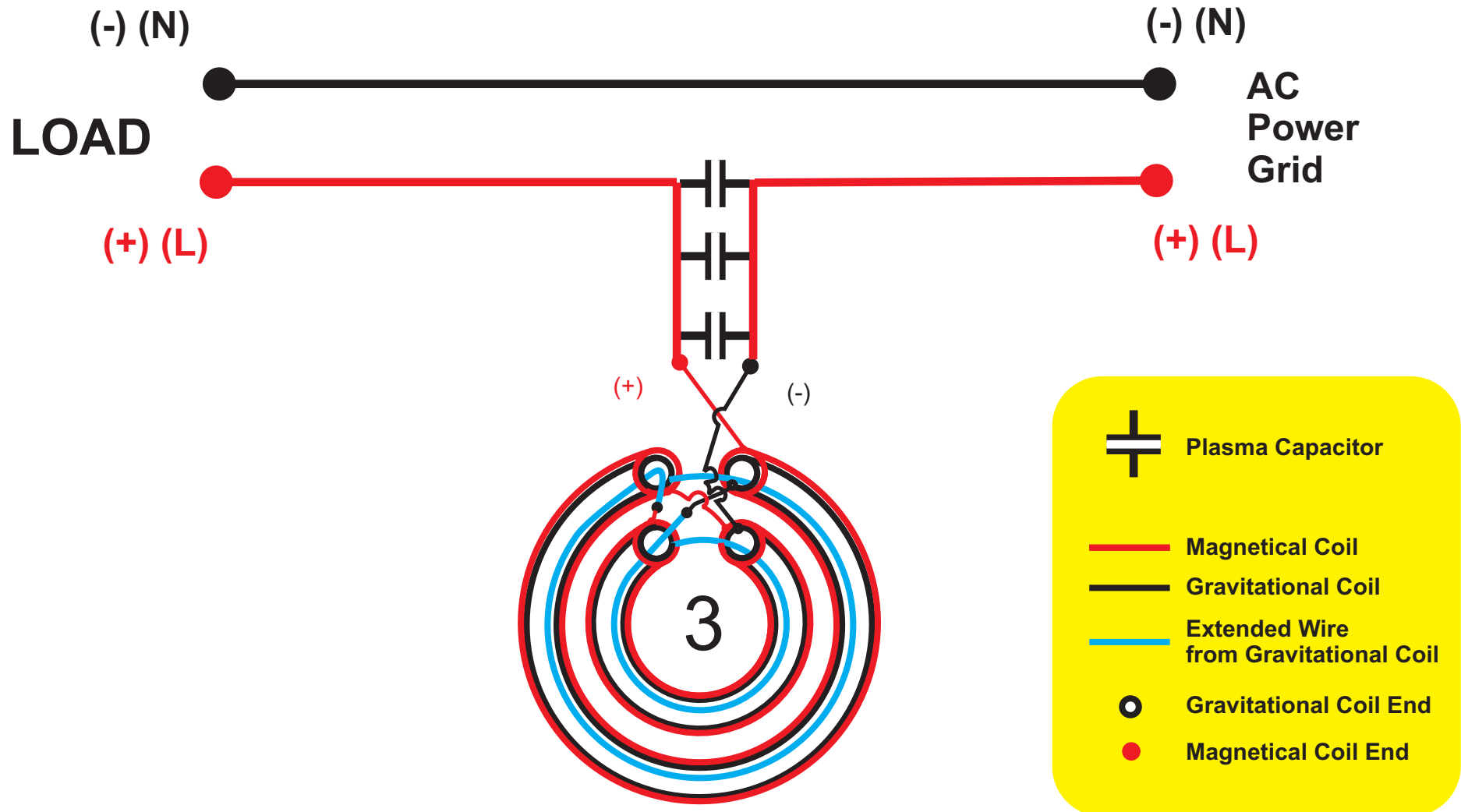

MAGRAV Power AC Grid Connection- Config 4

Keshe Foundation R&D Group
August 30, 2015

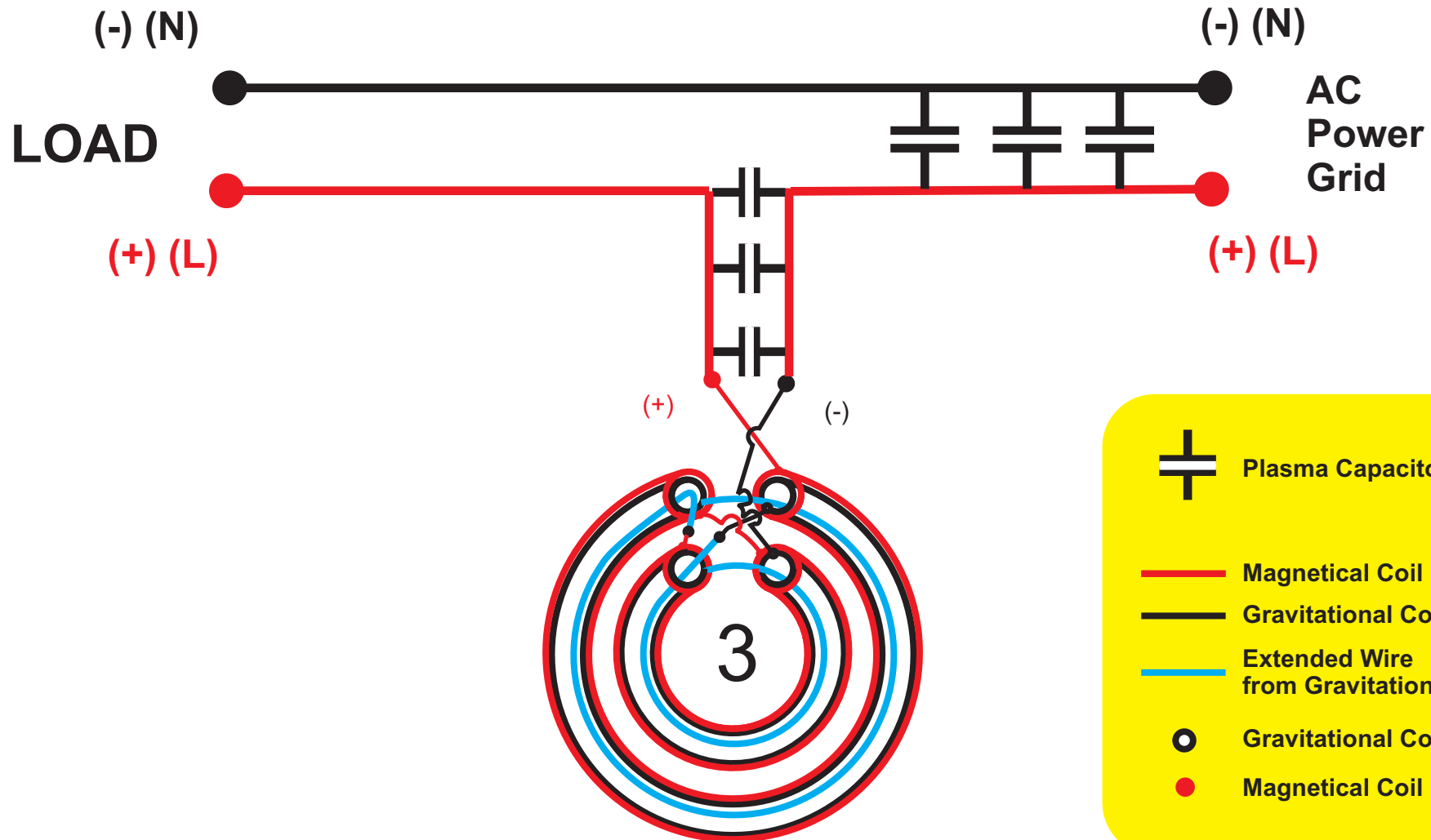



MAGRAV Power for Vehicle - Direct Connection

Keshe Foundation R&D Group
August 30, 2015





 Plasma Capacitor

 Magnetical Coil

 Gravitational Coil

 Extended Wire from Gravitational Coil

 Gravitational Coil End

 Magnetical Coil End

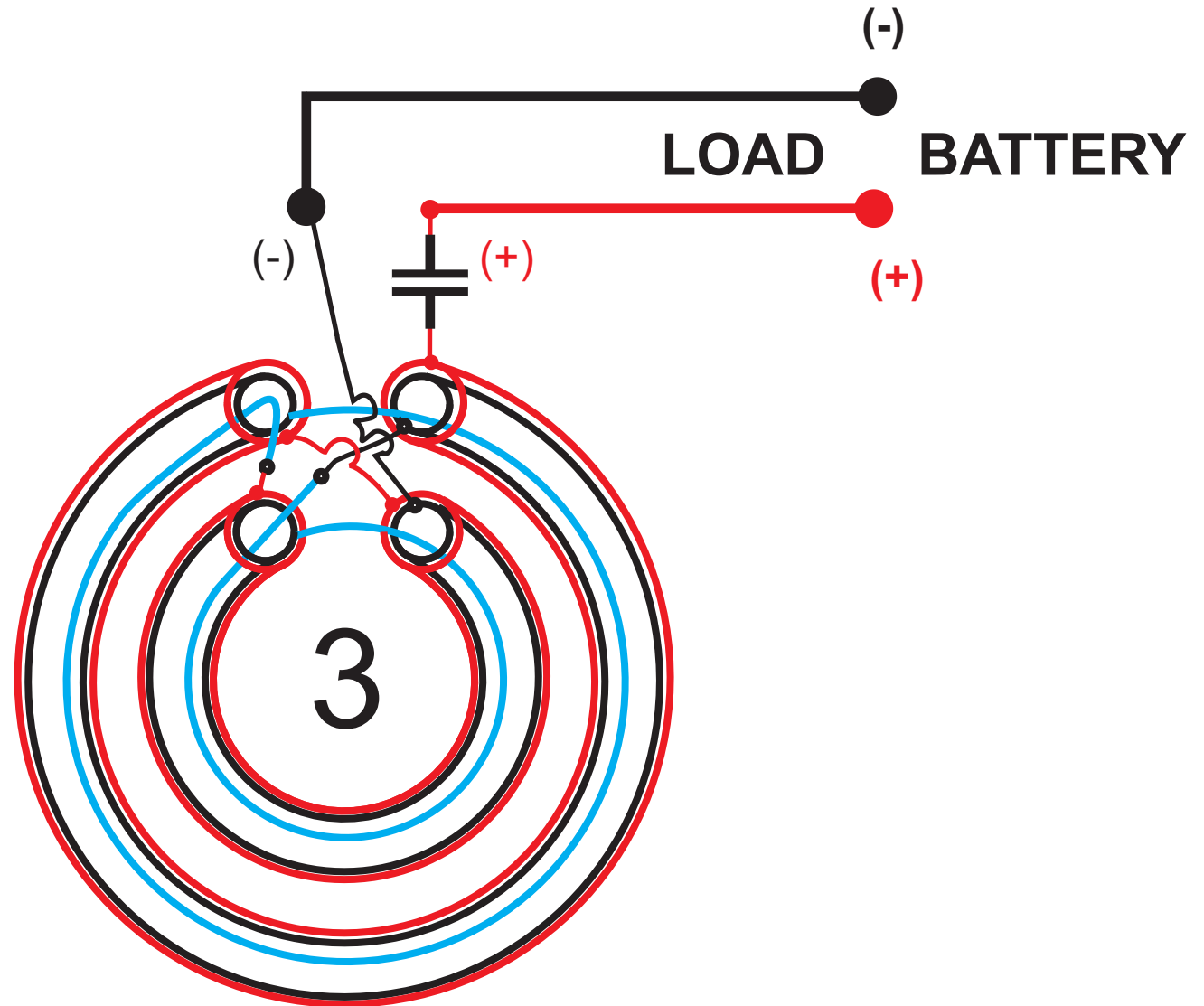

MAGRAV Power Supply (using conventional capacitors)

Common Electrical Term: **Power Factor Corrector Device** - This requires a connection from the Grid.
 How to Use: Connect to a power supply (Grid) and connect loads on Circuit Connection C_n .

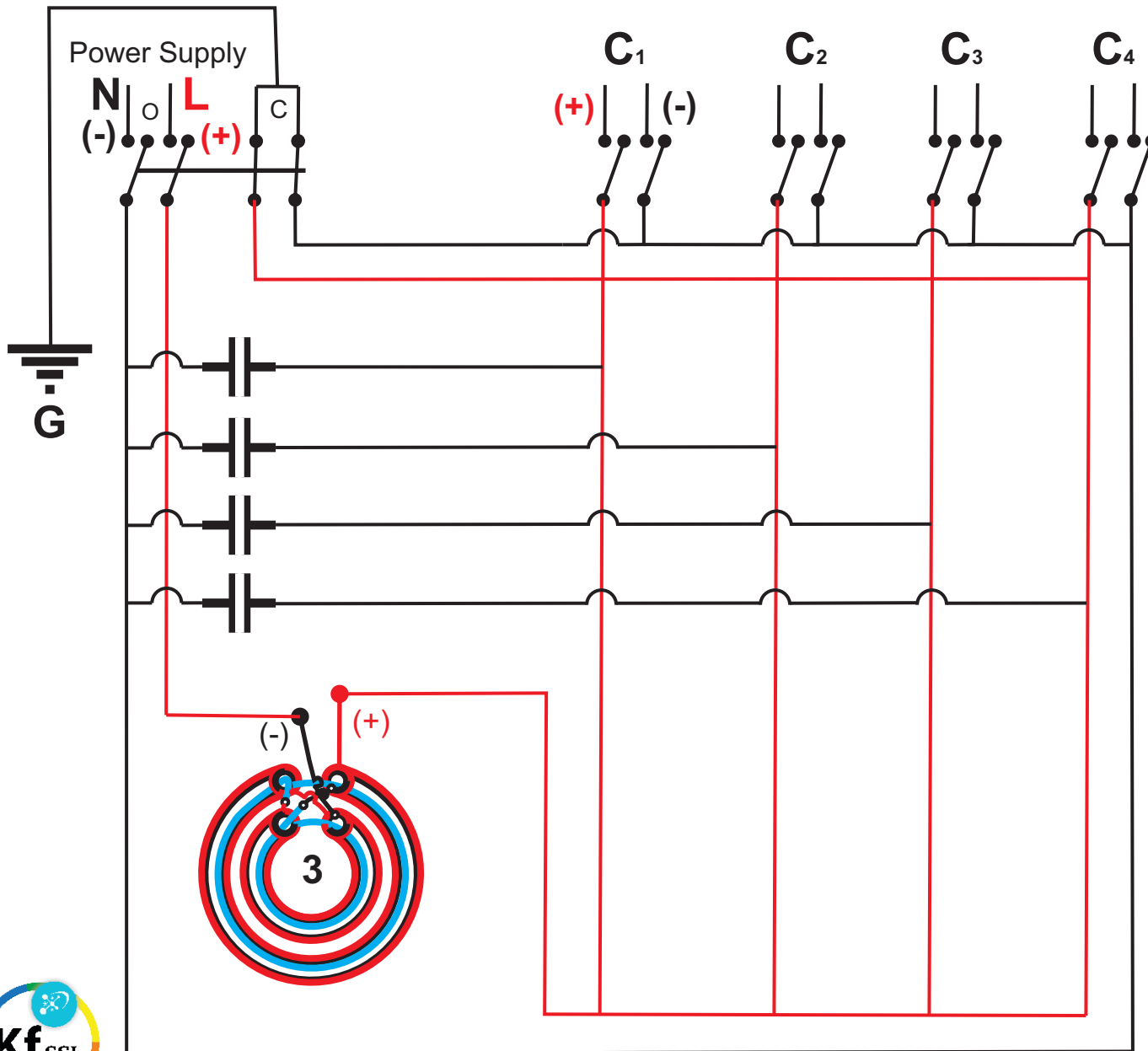

 Conventional Capacitor 2KVAR

 Positive Connection

 Negative Connection

 Toggle Switch

 Mechanically Interlocked Circuit Breaker (Open-Close)

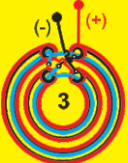
 Magrav Coil Set of 3 (Harmonic Filter using coreless nano-material)

C_n Circuit/ Load

Note:

1. Discharge the Capacitor to the Ground in few seconds once a month by switching off the system.
2. Magrav Coils and Capacitor can be increased according to the power requirement.
3. This set up is for 2.2Kw and can boost power up to 60% in the first month of operation.

House Wiring with MAGRAV Power simulated in a test set up

Keshe Foundation R&D Group
August 30, 2015

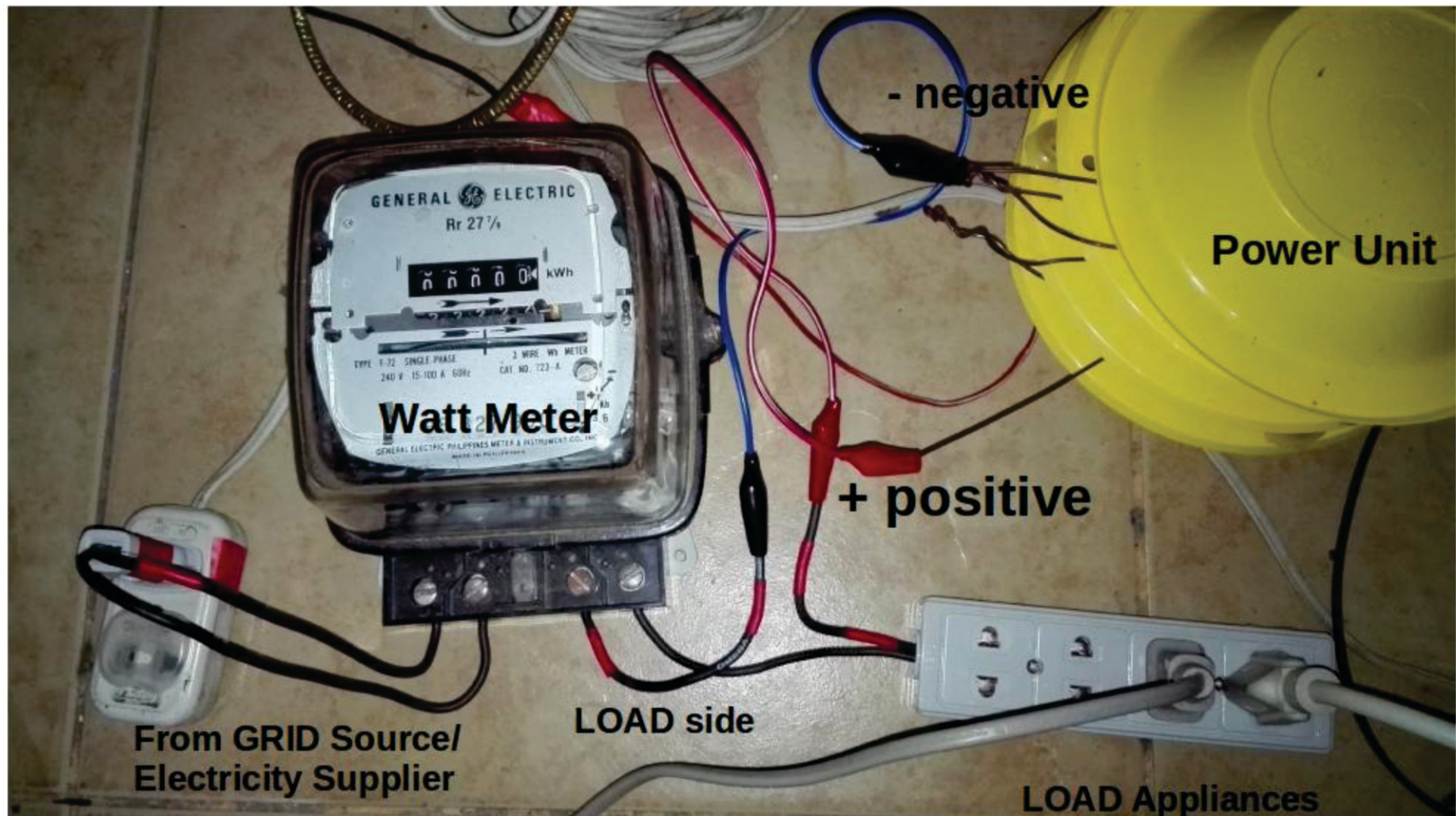

Wires with RED tape is the Hot wire and should be connected to the Negative of the Power Unit. The Positive of the Power Unit is connected to the Hot wire line of the LOAD or appliances.